

MLC16C-PE, MLC28C-PE, MLC18C-P3
 ON-OFF/ 3-step dimming function
 Updated Version



Introduction

- Stand-by power < 0.5W.
- Stand-by dimming level is optional, 10% / 25%.
- Integration of microwave motion sensor, daylight sensor and LED power supply.
- Automatic switching and dimming based on motion and light level.
- Constant current can be set via DIP switch.
- Compact size makes the drivers suitable to fix within most LED ceiling lights.
- Detection area, time delay and daylight threshold can be precisely set via DIP switch.

Sensor DIM LED drivers, originally pioneered by Merrytek, are innovative products integrated with HF motion detector, daylight sensor and LED power supply.

The products supply a simple energy-saving solution for LED ceiling lights. As all control parts are integrated in a same housing, it is very easy to assemble and save labor cost.

Compact size makes the drivers easy to be installed in luminaires and get more simple lighting structure.

As updated version adopts advanced sensor driver circuit, stand-by power is less than 0.5W, more energy saving. In addition, optional stand-by dim level is friendlier for actual use.



Max.6M



Light Sensor



Hold Time
5s-10min



Mounting Height
6m Max.



Automatic
On/off

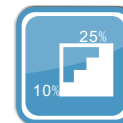

Automatic
Dimming



3 Years
Guarantee

Optional Function

ON-OFF Function

The products provide ON-OFF and steps dimming function for LED lighting, users can select the right function according to different applications.



With sufficient ambient light, the sensor does not switch on the lamp.

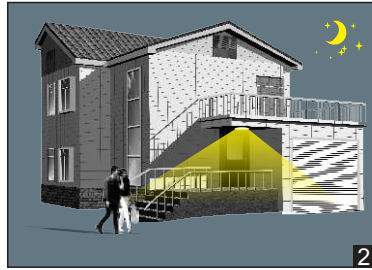

With insufficient ambient light, the sensor switches on the lamp when motion is detected.

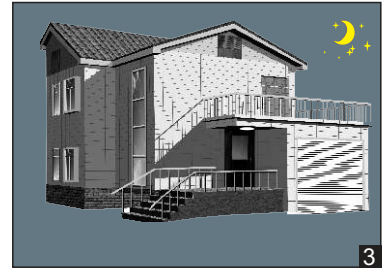

After hold time, the lamp gradually dims down if no motion detected.

3-step dimming function

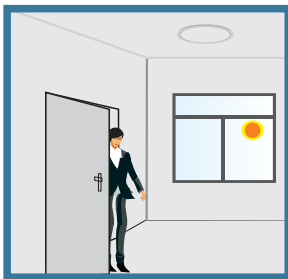

With sufficient ambient light, the sensor does not switch on the lamp.

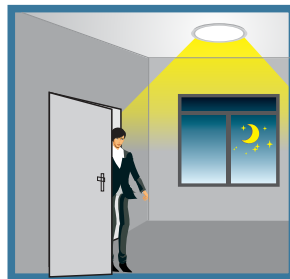

With insufficient ambient light, the sensor switches on the lamp when motion is detected.

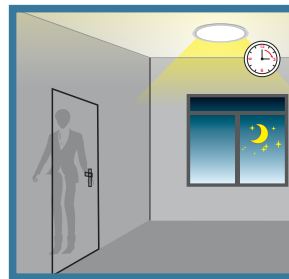

After hold time, the sensor dims the lamp at a low light level if no new motion trigger.

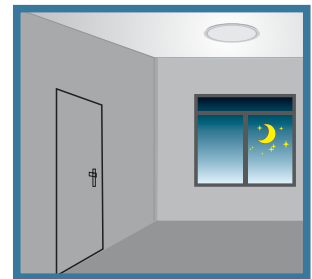

After stand-by period, the sensor switches off the lamp if no motion is detected in its detection zone.

Wiring scheme

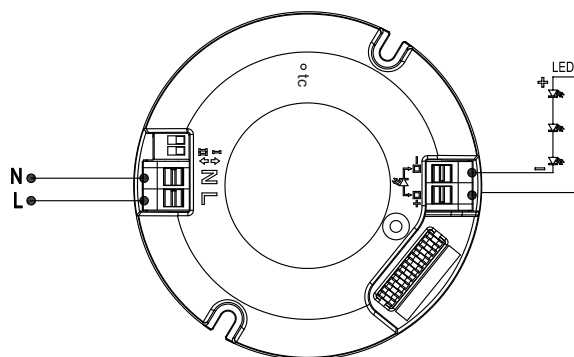

Detection Pattern

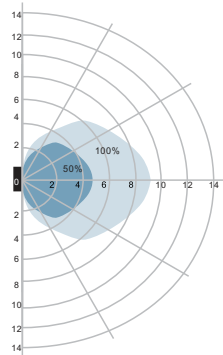

Wall mounting pattern (Unit: m)
Installation height: 1.5m

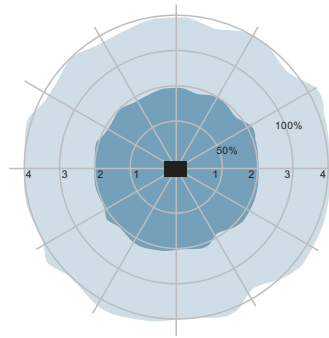

Ceiling mounting pattern (Unit: m)
Installation height: 3m

Technical Parameters

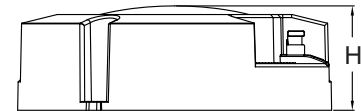
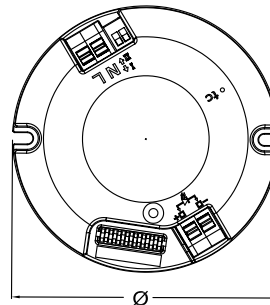
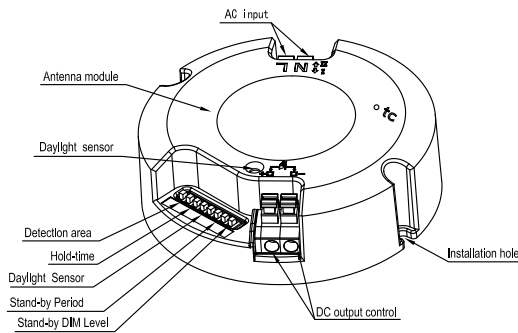

Unit: mm

Model No.	MLC28C-PE	MLC18C-P3	MLC16C-PE
Operating voltage	220~240Vac, 50/60Hz	220~240Vac, 50/60Hz	220~240Vac, 50/60Hz
Output constant current	450/550/600/700mA, set via DIP switch	350mA	300mA
Output voltage	22-40Vdc(450/550/600mA) 22-34Vdc(700mA)	28-52Vdc	28-52Vdc
Efficiency	≥84% (@Full load)	≥84% (@Full load)	≥84% (@Full load)
Power factor	>0.9 (@Full load)	>0.9 (@Full load)	>0.9 (@Full load)
HF system	5.8Ghz±75Mhz, ISM wave band	5.8Ghz±75Mhz, ISM wave band	5.8Ghz±75Mhz, ISM wave band
Transmitting power	<0.5mW	<0.5mW	<0.5mW
Power consumption	≤0.5W (standby)	≤0.5W (standby)	≤0.5W (standby)
Detection range	4m(@ 3m mounting height)	4m(@ 3m mounting height)	4m(@ 3m mounting height)
Detection area	50%/ 100%	50%/ 100%	50%/ 100%
Hold time	5s/ 90s/ 3min/ 10min	5s/ 90s/ 3min/ 10min	5s/ 90s/ 3min/ 10min
Stand-by period	0s/ 30s/ 10min/ +∞	0s/ 30s/ 10min/ +∞	0s/ 30s/ 10min/ +∞
Daylight sensor	5lux/ 15lux/ 50lux/ Disable	5lux/ 15lux/ 50lux/ Disable	5lux/ 15lux/ 50lux/ Disable
Stand-by DIM level	10%/ 25%	10%/ 25%	10%/ 25%
Mounting height	6m Max.	6m Max.	6m Max.
Motion detection	0.5~3m/s	0.5~3m/s	0.5~3m/s
Detection angle	150° (Wall installation) 360° (Ceiling installation)	150° (Wall installation) 360° (Ceiling installation)	150° (Wall installation) 360° (Ceiling installation)
Working temperature (Ta)	-25°C ~ 45°C	-25°C ~ 50°C	-25°C ~ 50°C
Size (ø x H)	82x27.25mm	68x28.5mm	68x28.5mm
IP rating	IP20	IP20	IP20

Setting

By selecting the combination on the DIP switch, sensor data can be precisely set for each specific application.

		1	
	I	ON	100%
	II	-	50%

Detection area

Detection area can be reduced by selecting the combination on the DIP switches to fit precisely each application.

		2	3	
	I	ON	ON	5S
	II	-	ON	90S
	III	ON	-	3min
	IV	-	-	10min

Hold time

Refers to the time period the lamp remains at 100% illumination after no motion detected.

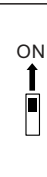
		4	5	
	I	ON	ON	Disable
	II	-	ON	50Lux
	III	ON	-	15Lux
	IV	-	-	5Lux

Daylight sensor

The sensor can be set to only allow the lamp to illuminate below a defined ambient brightness threshold.

When set to Disable mode, the daylight sensor will switch on the lamp when motion is detected regardless of ambient light level.
50lux: twilight operation, 15lux, 5lux: darkness operation only.

		6	7	
	I	ON	ON	0S
	II	-	ON	30S
	III	ON	-	10min
	IV	-	-	+∞

Corridor function (Stand-by period)

Refers to the time period the lamp remains at a low light level before it completely switches off in the long absence of people.

When set to “+∞”, the low light is maintained until motion is detected.
When set to “0s”, the light will turn off after hold time.

		8	
	I	ON	10%
	II	-	25%

Stand-by dimming level

The low light level you would like to have after the hold time in the long absence of people.